

ENIGMA[®]

SLIDING POCKET DOORS

Installation Guide

selo

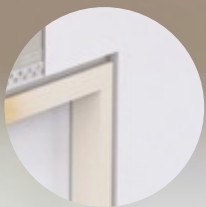

NFR S



Telescopic | Shadow Gap Trim

January 2023 | Revision E

SEL-PRT-00783

Thank you for choosing Enigma

To ensure the installation process is simple and efficient, we recommended you read this guide in full first. Specific tools are also required to complete the installation:



Pencil



Tape Measure



Knife



Hex Keys (metric)

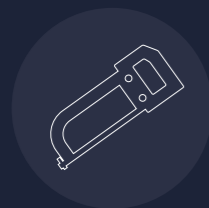

Hacksaw / Tin-snips



Laser Level



Cordless Screwdriver



Power Chop Saw

Getting started

Before you start installation ensure you have read and understood the instructions.

DELIVERY

The Enigma pocket door system will be delivered in two boxes. One is the pocket frame and the other is the trim surround.

If a door leaf has been ordered this will come separately.



Telescopic kit contents

Familiarise yourself with components included. All fixings will come pre-packaged to suit your specific project requirements.

FRAME FIXINGS

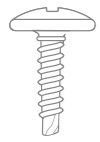

Type-1
19mm Self drilling
(Pan head)

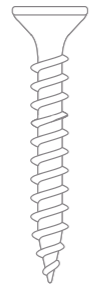

Type-2
40mm Screw
(Countersunk)

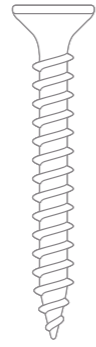

Type-3
50mm Screw
(Countersunk)

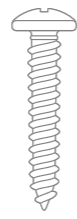

Type-4
30mm Screw
(Domed head)



Type-5
25mm Self drilling
(Countersunk)

TELESCOPIC COMPONENTS



Adjustable Pulley



Fixed Belt Clamp



Fixed Pulley



Belt



Moving Connector



Door Guide



Sliding Gear Set

FRAME COMPONENTS

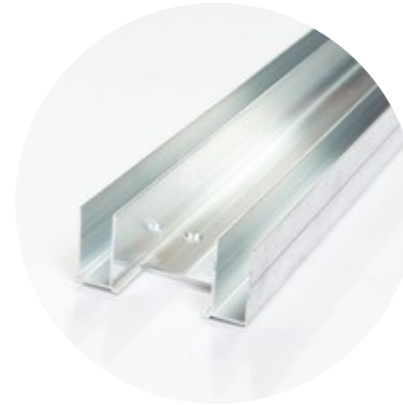

Base Channel



Head Channel



Leading Edge Jamb

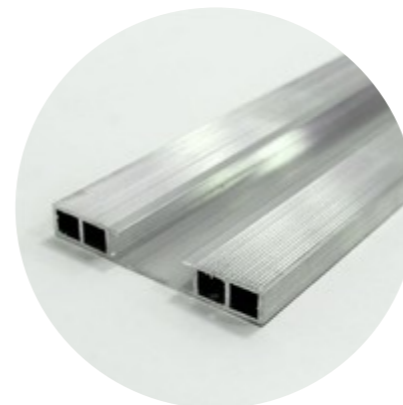

Intermediate Jamb



Timber Insert



Remote Stop



Door Channel Guide



Door Guide Pin



x1 End-block



Brush Strip

Wall construction preparation

The Enigma system can be fitted to steel or timber studwork partitions. If using steel you must ensure the head stud is strong enough to take the door weight.

IMPORTANT INSTALLATION NOTES

1. Studwork size

The studwork size required is **146mm**.
If using steel studs a 146mm Head and Base Track should be used along with 144mm Uprights.

2. Steel studs

If using steel studs, timber inserts are required within the studs to provide additional strength.

3. Doors above 2300mm

If the door height you are installing is above 2300mm then using 2 layers of plasterboard is recommended.

This applies to Concealed frame NFR and Visible frame NFR. To order kits to suit two layers of plasterboard, add double boarded to the product description.

Bespoke requirements?

Enigma can be customised to suit bespoke projects. In principle, the installation process remains the same, however certain installation dimensions may differ. Please contact the Selo team to discuss your bespoke requirements.

1

STRENGTHEN HEAD

When constructing your stud partition, please ensure the head is strong enough to take the weight of the sliding door that will hang from it.



2

CHECK SIZE WITH SCHEDULE

When forming the structural opening, please ensure you are working to the correct opening size provided on the door schedule.



3

LEVEL-UP

Ensure the opening is square and plumb.

IMPORTANT

We recommend the use of a laser level for setting out.

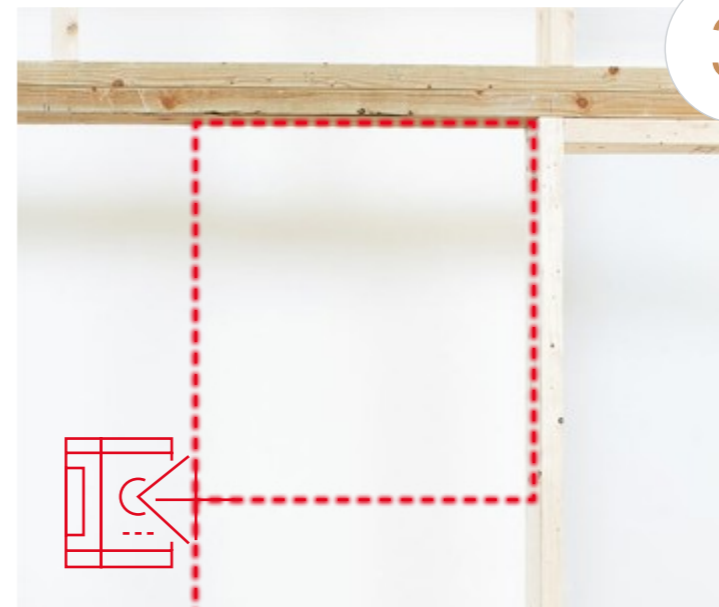

NFR S Calculations

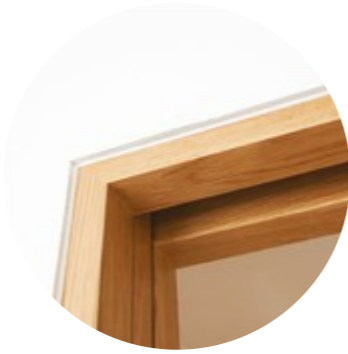

SIZE CALCULATIONS

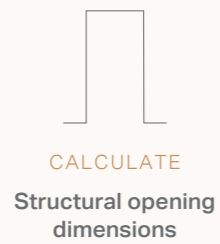

Single Door (Telescopic)
 $S/O\ width = x3\ Door\ leaf\ width + 26mm$
(Inc. 10mm packer)
 Structural opening height = Door leaf height + 90mm

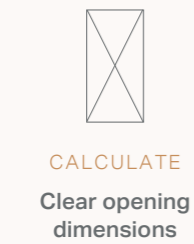

Single Door (Telescopic)
 $Clear\ opening\ width = x2\ Door\ leaf\ width - 96mm$
 Clear opening height = Door leaf height - 16mm

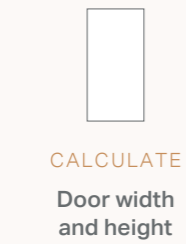
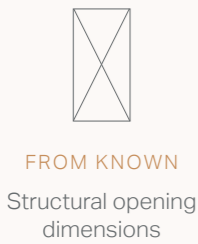

Single Door (Telescopic)
 $Door\ width = Structural\ opening\ width - 16mm \div 3$
 Door height = Structural opening height - 90mm

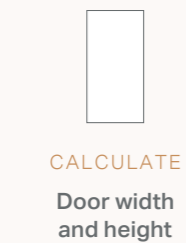
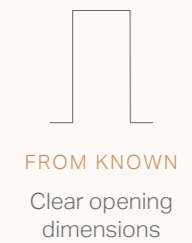

Single Door (Telescopic)
 $Door\ width = Clear\ opening\ width + 96mm \div 2$
(Excl. 10mm packer)
 Door height = Clear opening height + 9mm

Base Channel Calculations

Please refer to **Step 4** of the **Telescopic Frame Installation** instructions shown on **page 12**.



Telescopic frame installation

1

PREPARE HEAD CHANNEL & SLIDING TRACK



Telescopic doors

1a Measure the structural opening width and cut the **Head Channel** to that length.

IMPORTANT

On our widest kit, two head channels may be supplied.

1b Remove the **Remote stop**, then cut the **Sliding Top-tracks** to the Head Channel length, less 75mm.

2

HEAD CHANNEL PREPARATION

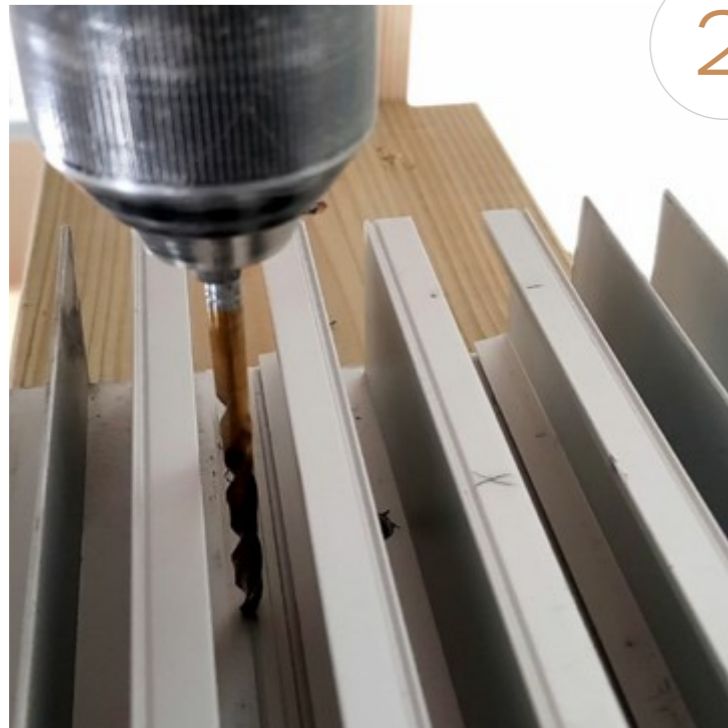

Telescopic doors

Line the end of the **Sliding Top-Tracks** with the end of the **Head Channel** and pilot drill the holes with a **6mm** drill bit.

IMPORTANT

Ensure the groove in the centre of the track and the Head Channel line up as shown. This will leave a 75mm gap which must be positioned at the strike end of the pocket.

3

FIT THE HEAD CHANNEL AND TOP TRACK



3a Fix the **Head Channel** in place and fix using **Type-2** screws making sure the 75mm gap for the tracks is at the strike side of the pocket.

3b Slide the Remote Stop into the **Secondary Sliding Top Track**. See below diagram to identify the **Primary** and **Secondary Leaf**.

3c Line the **Sliding Top Tracks** with the pilot holes drilled in Step 2 and fixing using **Type-3** screws.

Only use the silver **Type-3** screws provided to secure the tracks into place. **Use of a larger screw will prevent the Remote Stop from sliding freely within its groove.**

It will be necessary to slide the **Remote Stop** back to access all the fixing holes in the track.

PRIMARY & SECONDARY DOOR DIAGRAM

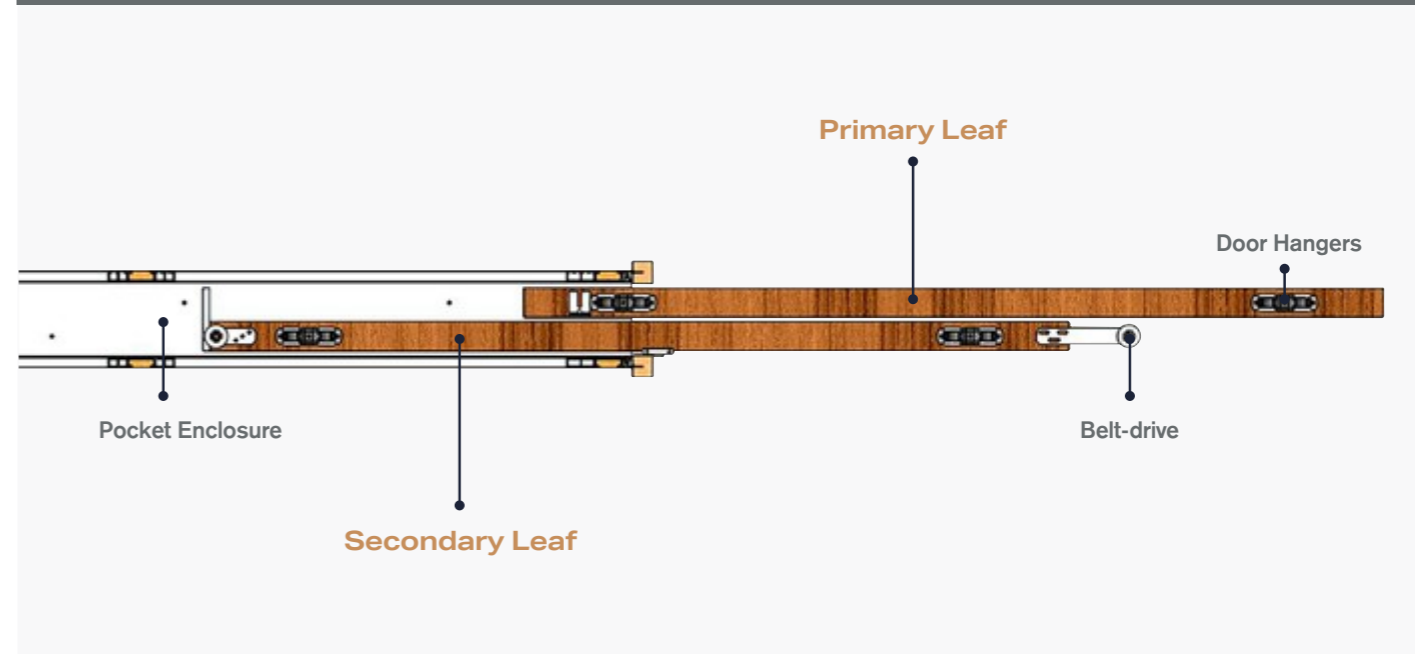

Base Channel position calculations

NFR Shadow Gap Trim

$X = \text{Door Width} \times 2 \text{ (minus) } - 16\text{mm}$

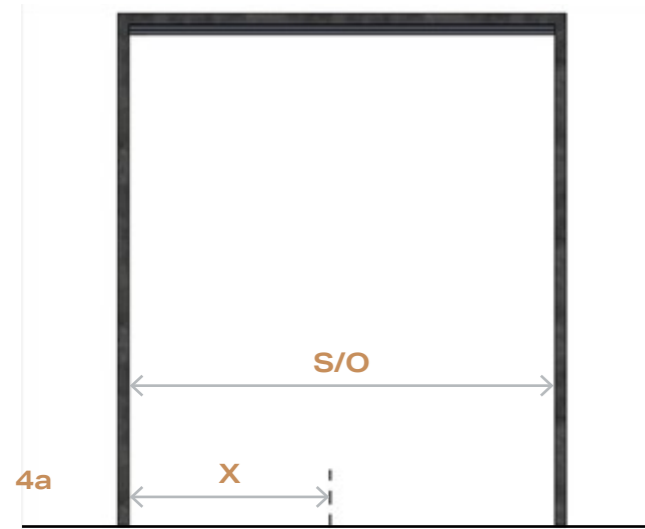

4

CALCULATE LENGTH OF BASE CHANNEL

To accurately determine the length of the **Base Channel**, first calculate the required clear opening (**X**) using the Base Channel position calculations on the left.

Measure back from the **Strike Stud** and mark the measurement on floor.

Cutting Base Channel to size

4a Measure the **Structural Opening** and minus **X**.

4b Ensure the **Base Channel** is positioned in relation to where the **Primary Leaf** contacts the strike trim. Cut the **Base Channel** from the end inside the pocket.

IMPORTANT

If provided with a cut-to-size system, skip to Step 5.

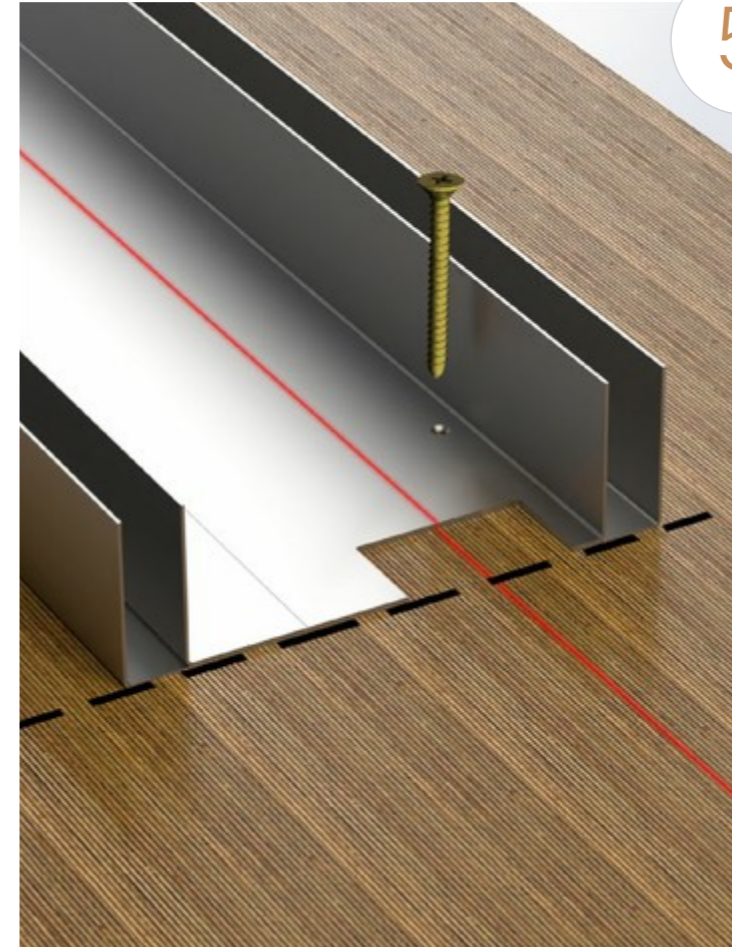
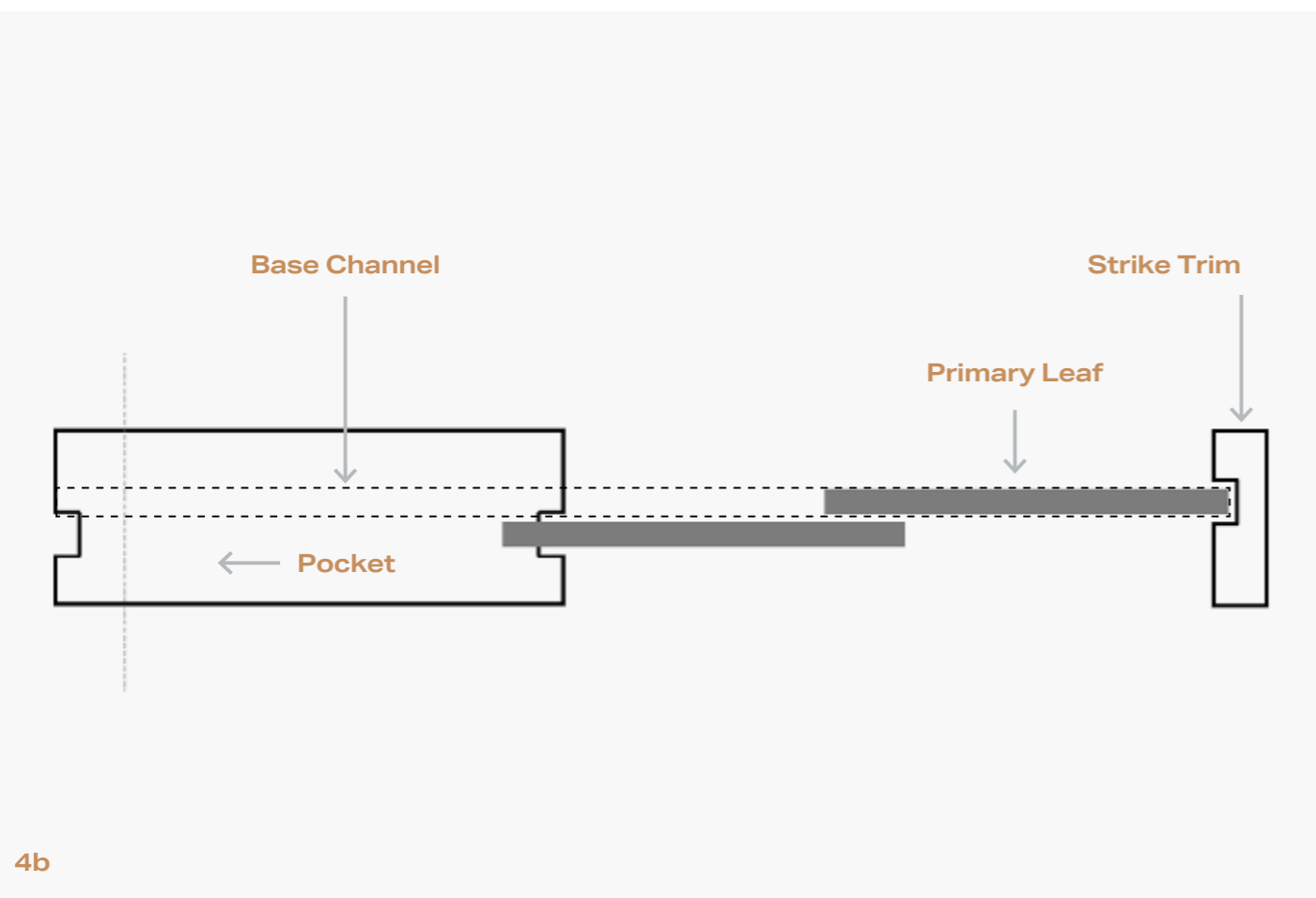

5

LINING UP & FIXING BASE CHANNEL

Place the **Base Channel** on the floor between the line marked in **Step 4** and the rear stud.

At this stage it is vital that care is taken to ensure that the centre lines of the **Base Channels** are in line and plumb with the **Head channels**. Any deviation in this alignment will result in misaligned doors and trims.

Secure to the ground with **Type-2** fixings.

6

FIT DOOR GUIDE PIN

Fit the door guide pin at the finished floor level with **Type-4** fixings. The pin offset needs to be facing the strike stud and aligned centrally with the centre line on the Base Channel.

If your installation requires the door guide pin to be raised up - use the 1mm stackable packers

IMPORTANT

1. The pin needs to be fitted at FFL (finished floor level). If the finished floor is not yet installed, fitment of the floor pin can be delayed until the flooring is completed.

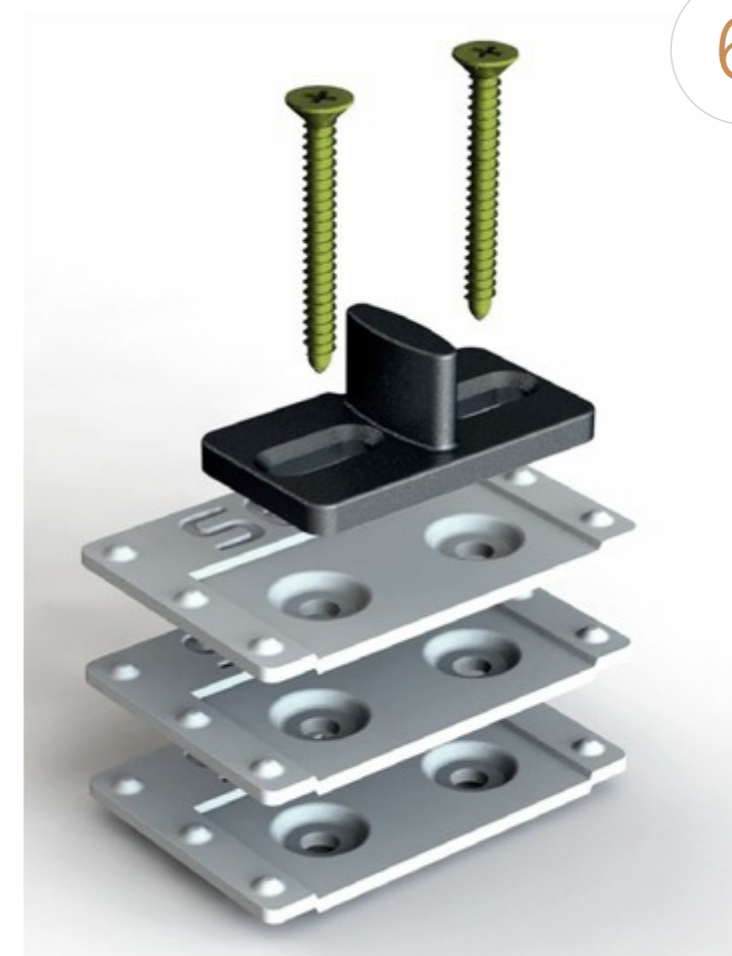



7

CUT LEADING EDGE & INTERMEDIATE JAMB

Cut the **Leading edge jamb** and **Intermediate jamb** 15mm less than the structural opening height.



8

CUT & FIT INTERMEDIATE TIMBER INSERT

Cut the intermediate **Timber insert** 100mm shorter than the aluminium jamb and slide the insert into the **Intermediate jamb** so it sits 50mm from each end.

IMPORTANT

When using door leaves wider than 926mm the kit will be supplied with extra intermediate jambs to be fitted equally space within the pocket width.



9a

9

FIT POCKET SIDES & FIX THE JAMB

9a Install the **Intermediate Jambs** in between the rear pocket stud and the leading-edge jambs, then fix the **ONE** leading edge jamb.

9b Slide the **Leading edge jamb** into **Base Channel** with notched end at the top, so the flange sits hard against the end of the **Base Channel**.

Plumb the jamb and fix into place using one **Type-1** screw top and bottom as shown in the image. Must be posited furthest from the opening.



9b

10

FIT BRUSH STRIP

Cut the **Brush Strip** to length and fit to the leading edge aluminium profile.



Telescopic door leaf installation

With the Enigma concealed system the door leaf can be installed after the frame has been plastered.

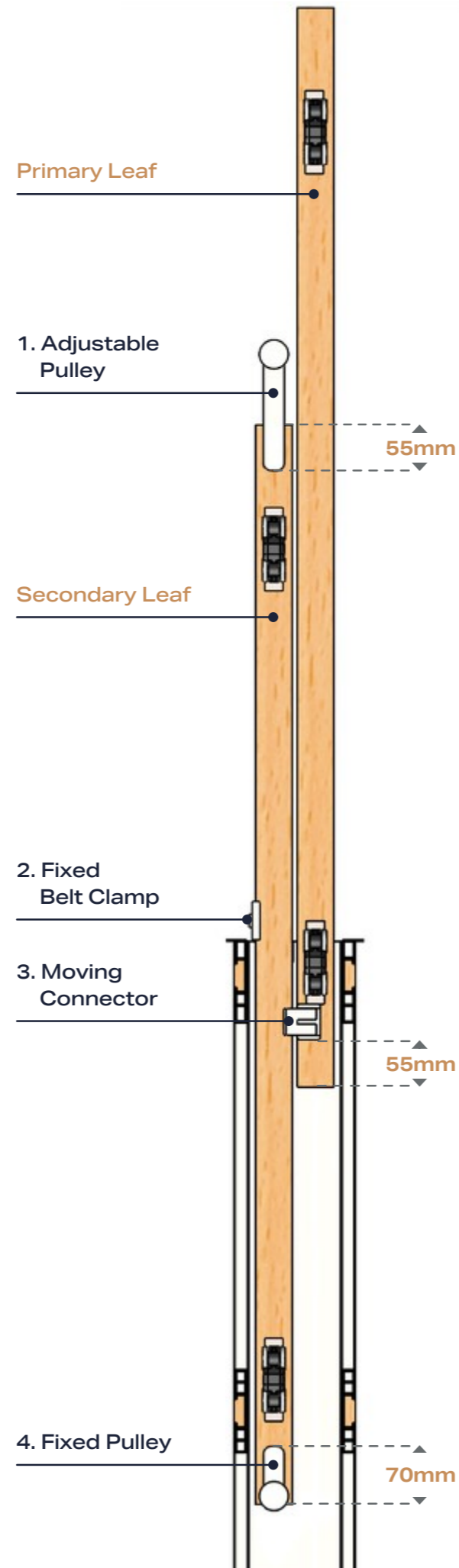

1

INSTALL TELESCOPIC GEAR

Install the x4 components of the **Telescopic Gear** to the tops of the doors as shown.

IMPORTANT - Do not fix to belt yet

2

FIT DOOR HANGER BRACKETS

Fit the head brackets **150mm** from the edge of the door leaf to centre of the bracket, ensuring both brackets are the same way up.

Pilot and use the **Type 3 screws** provided.



3

INSTALL MOVING CONNECTOR

Install the **Moving Connector** to the top of the **Primary Leaf** as shown ensuring access to the hex bolt.



4

FIT THE GUIDE CHANNEL

Apply a thin bead of adhesive into the groove in the bottom of the doors and then tap the plastic channels into position





5

ASSEMBLE GEAR

Wipe out the tracks with a damp cloth to remove any swarf or debris.

5a Screw the bolts into the trolley several turns and then insert the trolleys into the track. (Two wheels in each track)

5b Adjust the bolts to achieve a gap approximately **40mm** between the underside of the track and the top of the bolt.



8

FIT THE FRONT DOOR STOP

Slide the white nylon door stop into the track and fix into place by tightening the grub screw.

This can be finally adjusted once the trims are installed.



6

HANG DOORS

Hang the doors onto the roller wheel bolts ensuring the doors run smoothly.

IMPORTANT
Do not fasten the bolts at this stage as further adjustments may be necessary.



9

FIT TRACK END BLOCK

The track **End-block** fits at the end of the track for a single door and in the middle of the two tracks for a double door.

First drill a pilot hole and fix the block into place using the **Type-9** screw.



7

INSTALL FIXED BELT CLAMP

Install the **Fixed Belt Clamp** flush against the **Secondary Leaf Head Track**. (Pilot holes may be required). The back edge of the **Fixed Belt Clamp** must be inline with the aluminium **Leading Edge Jamb** (as show with the white dotted line).

NOTE
The **Head Channel** from this image has been removed to aid clarity.

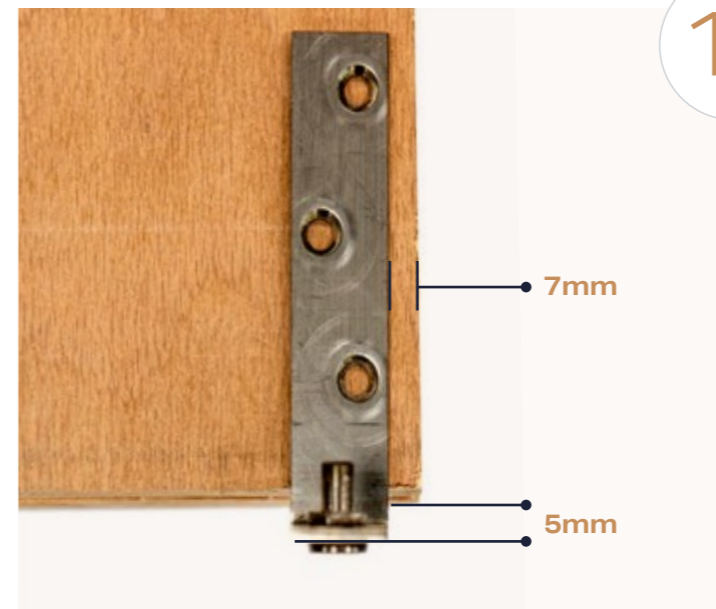

10

INSTALL DOOR GUIDE

Install the "L" shaped **Door Guide** to the heel of the **Primary Leaf**, ensuring to leave the pin loose for adjustment later.



11

ADJUST GAPS

Clamp **6mm Packers** between the doors top and bottom to keep the doors from binding and to maintain correct distance. Slide the doors left and right in the pocket to get even gaps between the pocket sides and the door leaves.

Once the gaps are even, tighten the **Hanging Bracket Bolts** (Step 6) tight enough to prevent sideways movement and **remove the Packers**. Tighten the **Door Guide** as per the previous step.

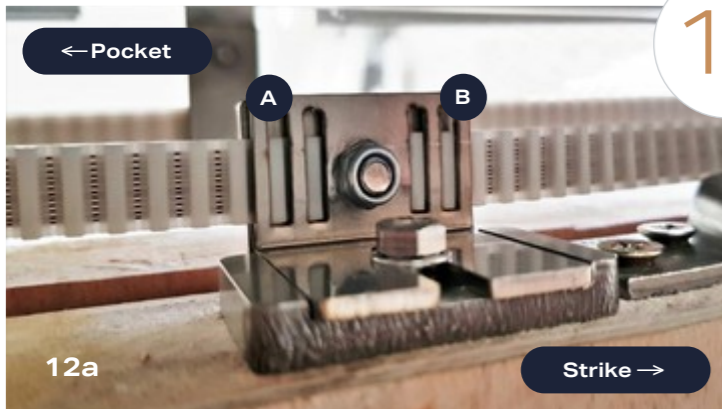

12

INSTALL BELT

12a Start by fixing the **Belt** into part **A** on the **Moving Belt Connector** (Belt Connector fixed to the top of the door).

12b Thread the Belt around the **Pocket-side Roller** on the door followed by the **Strike-side Roller**, then back to the **Fixed Belt Connector** to measure the length of Belt required.

IMPORTANT

Make sure that the belt is straight. Adjust the **Moving Belt Connector** (12a) to straighten if required.

Cut the **Belt** to length and fix into part **B** of the **Moving Belt Connector**.

IMPORTANT

Ensure that the **Belt** is not loose or rubbing on the **Door** or any **Bolts** etc.

12c Slide the doors back into the pocket so they are both flush and in the fully open position, then secure the **Belt** into the **Fixed Belt Connector**.

IMPORTANT

Make sure that the belt is straight. Adjust the **Moving Belt Connector** (12a) to straighten if required.



12b



12c



13

TIMBER LIPPING COVER

13a Using the **Type-2 Screws** included, fix the **Timber lipping** to the rear of the **Secondary leaf** to block the view into the pocket when the door is open.

13b The timber should be flush with the front and bottom face of the door, and overlap the primary door to ensure it doesn't catch inside the pocket.

13a

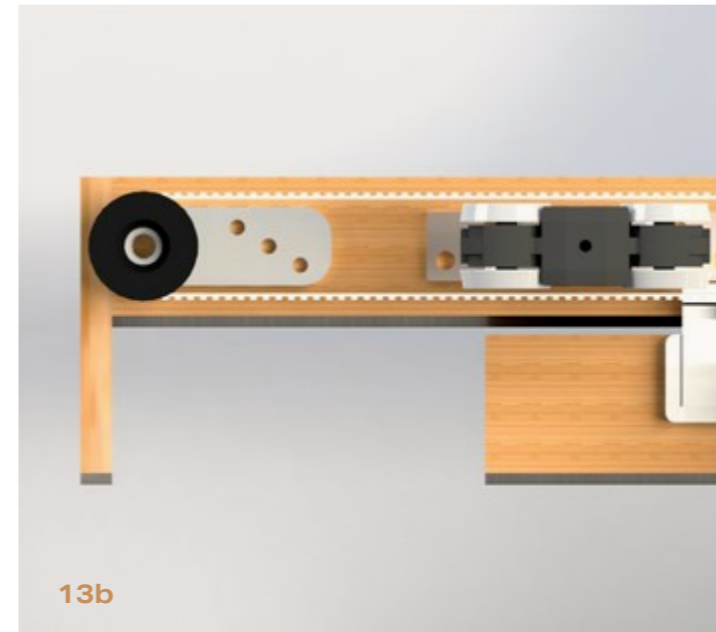

13b



14

PLASTERBOARD THE WALL

Plasterboard over the pocket along with the rest of the wall using the **Type-5** self drilling screws provided. It is vital to ensure the leading edge jambs remain completely vertical and plumb once boarded.

It is essential to clear out all swarf or debris that may be in the top track and bottom channel at this stage.

Shadow gap trim installation

Now the pocket door frame is installed you are ready to fit the Shadow gap trim.

SUPPLIED TOOLS



Hex Key

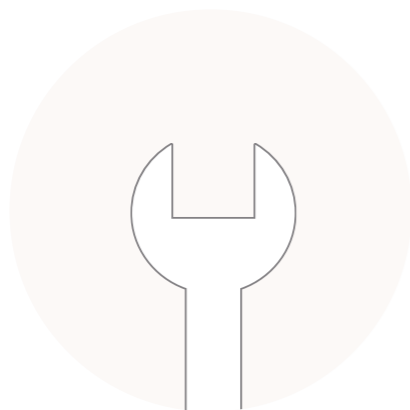

Spanner

TRIM FIXINGS



Type-5
25mm self-drilling screws

TRIM FIXINGS (cont.)

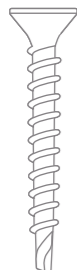

Type-7
35mm self drilling
drywall screws

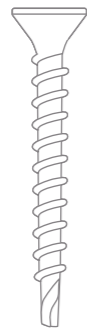

Type-8
42mm self drilling
drywall screws



Type-9
50mm gold screws



Panel Pins
30mm

TRIM COMPONENTS

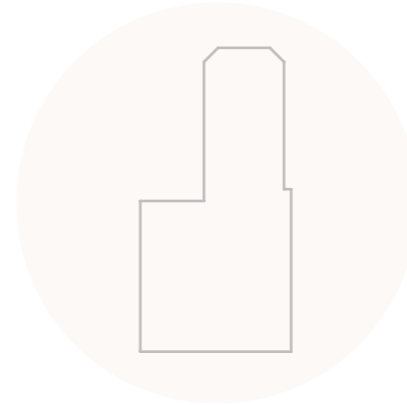

Head Trim
Single door x1 / Double door x2

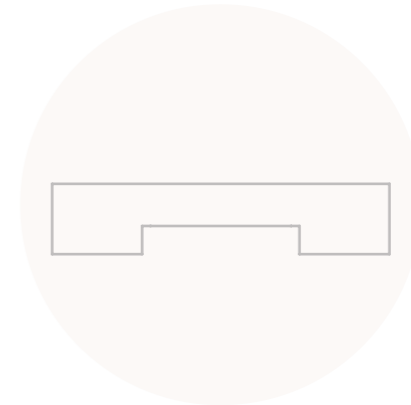

Strike Trim
Single door x1 / Double door n/a



Leading Edge Trim
Single door x2 / Double door x4

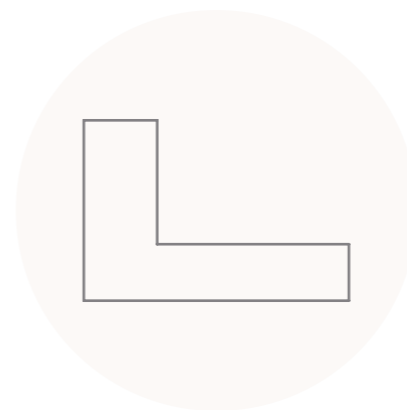

Shadow Gap Cover Trim
Single door x5 / Double door x6



Shadow Gap Plaster Bead



Strike Jamb Seals



1

INSTALL LEADING EDGE TRIM

Cut the **Leading Edge Trims** to the height of the opening and slot them over the flange on the leading-edge aluminium jamb, with the grooves for the brush/intumescent seal facing in towards the door.

They must be secured into position with the **Type-5** screws at **300mm** intervals. Please note that the timber will need to be pilot-holed first.



2

LINE THE DOOR UP

If required, the door can now be trued into alignment with the leading-edge trims by adjusting the hanger bolts up or down as necessary.

When you're happy that everything is aligned and the gaps between the door and trims are equal, lock the bolts firmly into position by winding down the locknuts.

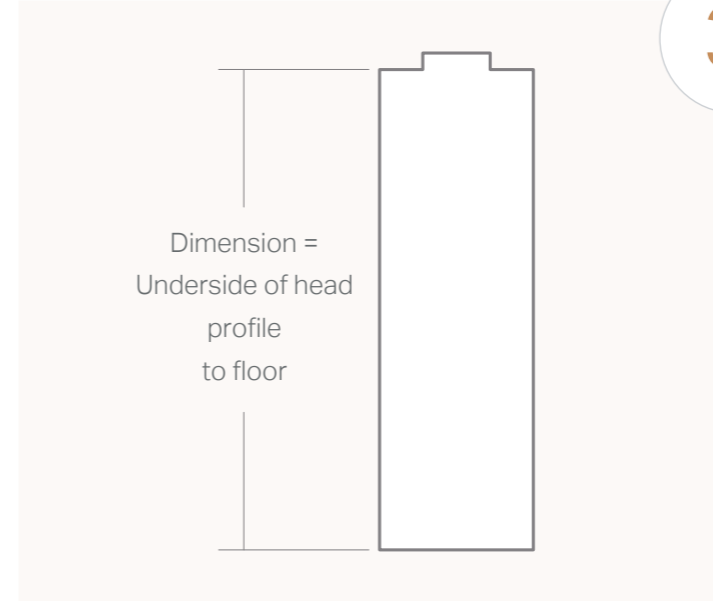

3

INSTALL STRIKE TRIM

Cut the **Strike trim** as per the drawing measuring **from** the notch to the end that is not notch. Cut the end that is **not notched**.

Then fit the notched end centrally in the **Head Channel**. Plumb the strike trim using a level so it is aligned centrally with the **Head Channel** and fix into place using the **Type-9** screws.

IMPORTANT

When installing double doors the strike jamb will not be used.



4

SET CLOSER STOP

Adjust plastic clip, so the door leaf closes and is held in place, against the strike jamb.



5

INSTALL THE HEAD TRIM

Cut the **Head trim** the distance between the two timber side jambs. Slot into place in the head and fix using **Type-5** screws.



6

2ND LAYER OF PLASTERBOARD

Clad the pocket with a second layer of plasterboard over the timber frame using **Type-7** screws.

IMPORTANT

See next page for plasterboard positioning.



8

FIT THE SHADOW GAP PLASTER BEAD

Cut the shadow gap plaster bead to length mitring it at the corners.

Fix into place using **Type-8** screws.



6a

2ND LAYER OF PLASTERBOARD

The second layer of plasterboard needs to stop short of the timber frame edge by **40mm**.

This allows for the shadow gap and trims.



9

TAPE & JOINT / PAINT

Now the wall can be tape and jointed and wall and trims painted.

IMPORTANT

We recommend tape and jointing not plastering.

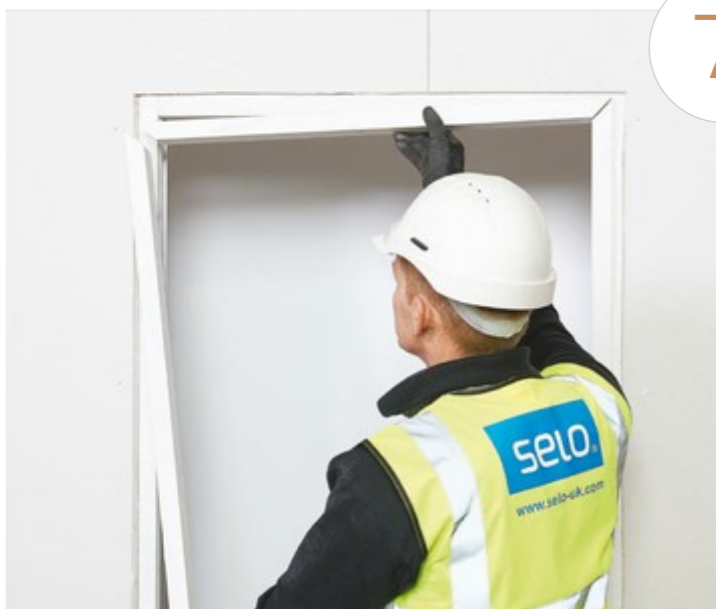

7

FIT THE SHADOW GAP TRIM

Cut the timber shadow gap trim to height and width. It will need to be mitred at 45 degrees in the corners.

Fix the trim into place using **30mm Panel Pins**.

IMPORTANT

Due to the increased size of the trim on the passive strike side, it would benefit from additional glue as well as pins to ensure no movement can take place.



10

FIT SEALS

Batwing strike seals

Fit the rubber seals to the corners of the strike trim.

11

ADJUST REMOTE STOP

Adjust the remote-stop so it holds the door flush with the leading-edge trims when the rear trolley is engaged on the stop.

When correctly aligned, fix the stop into place with the self-drilling screw provided making sure that all swarf is wiped/hovered from the track. Any debris left in the track will cause the door to 'rumble' as it opens and closes.

**Congratulations!**

You've now completed the installation of your Enigma doorset.





Innovation | Configuration | Strength

The Complete Pocket Door System



Visit our website for the very latest design styles.

www.enigmapocketdoors.com



ENIGMA
SLIDING POCKET DOORS

Technical support helpline 020 3880 0339

Email sales@enigmapocketdoors.com

K2 Kents Hill Business Park Timbold Drive Milton Keynes MK7 6TT

INNOVATION BY SELO.