

ENIGMA®

SLIDING POCKET DOORS

Installation Guide



FD30 Visible Trims

October 2022 | Revision C

SEL-PRT-00798



Thank you for choosing Enigma

To ensure the installation process is simple and efficient, we recommended you read this guide in full first. Specific tools are also required to complete the installation:



Pencil



Tape Measure



Knife



Hex Keys (metric)



Hacksaw / Tin-snips



Laser Level



Cordless Screwdriver



Power Chop Saw

Fire certification guidance

IMPORTANT

If fitting a fire rated lock refer to the Global Assessment for intumescent detail or contact Selo.

Flush door handles - Based on the test evidence cited within CNA/F15315 Revision D which permits the machining of the Halspan 30 Prima/Optima door core to a minimum thickness of 18mm in order to achieve a panelled door appearance when using a 54mm overall thick core (in accordance with Section 6.2) or 8mm when using a 44mm overall thick core. Flush door handles may be fitted subject to the limitations below:

1. Where handles are fitted back to back, handle thickness is limited to 9.5mm.
2. Where handles are staggered between the two leaf faces a maximum handle thickness of 13.5mm is permitted, the handle pockets must be separated by a minimum of 100mm of leaf core material.
3. Handle dimensions are limited to a maximum of 600mm in height and 60mm in width at the thicknesses shown above.
4. Handles must be fitted a minimum of 60mm from leaf edges.
5. The pocket formed to receive the handles must be lined with 1mm thick Interdens. Refer to the Global Assessment for intumescent detail or contact Selo.

Getting started

Before you start installation ensure you have read and understood the instructions.

DELIVERY

The Enigma pocket door system will be delivered in two boxes. One is the pocket frame and the other is the trim surround.

If a door leaf has been ordered this will come separately.



FD30 V frame kit

Familiarise yourself with components included. All fixings will come pre-packaged to suit your specific project requirements.

SYSTEM COMPONENTS

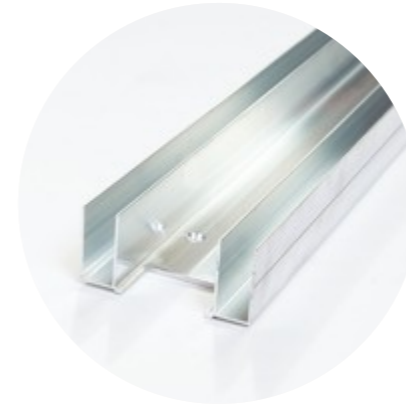

Base Channel

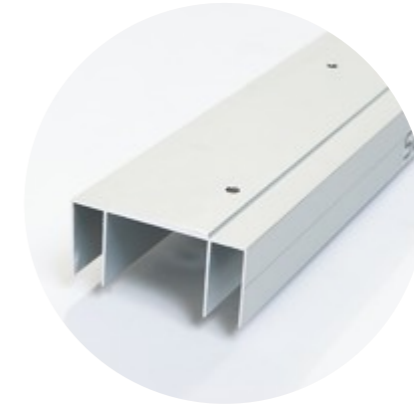

Head Channel



Leading Edge Jamb

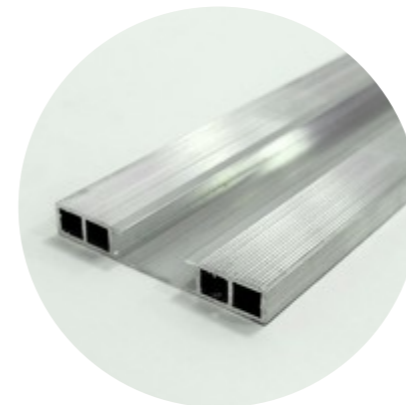

Intermediate Jamb



Timber Insert



Remote Stop



Door Guide Pin & Channel



Sliding Gear Set



Brush Strip

FRAME FIXINGS

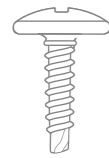

Type-1

19mm self drilling pan head screw

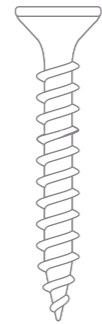

Type-2

40mm screw

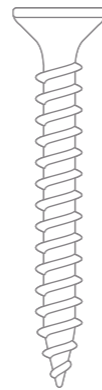

Type-3

50mm screw

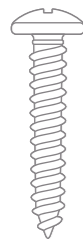

Type-4

30mm screw



Type-5

25mm self drilling screw

Wall construction preparation

The Enigma system can be fitted to steel or timber studwork partitions. If using steel you must ensure the head stud is strong enough to take the door weight.

IMPORTANT INSTALLATION NOTES

1. Studwork size

The studwork size required is **94mm**.
If using steel studs a 94mm head and base track and 92mm uprights should be used.

2. Steel studs

If using steel studs, timber inserts are required within the studs to provide additional strength.

3. Doors above 2300mm

If the door height you are installing is above 2300mm then using 2 layers of plasterboard is recommended.

This applies to Concealed frame NFR, Visible frame NFR and Visible frame FD30. To order kits to suite two layers of plasterboard add the suffix (145) to the product code.

4. Allow for Accessories

If you are using a soft closer, touch latch or simultaneous opening mechanism then ensure you familiarise yourself with these instructions first.

5. Self-supporting Head

For situations in high rise buildings where you cannot fix to the ceiling or soffit then use the Enigma Self-supporting Head installation detail.

Follow standard Enigma instructions to calculate your studwork structural opening and add the following dimensions: **Width +94mm** and **Height +44mm**.

Ensure you refer to the specific Self-supporting Head installation instructions for further details.

Bespoke requirements?

Enigma can be customised to suit bespoke projects. In principle, the installation process remains the same, however certain installation dimensions may differ. Please contact the Selo team to discuss your bespoke requirements.



FD30 V Calculations

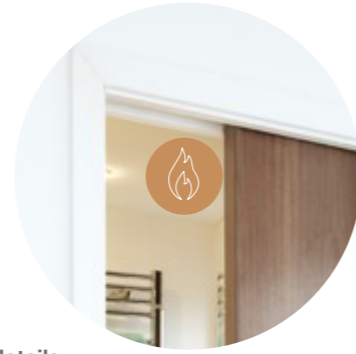

REQUIRED ADAPPTIONS

SIMULTANEOUS OPENING › The door leaf needs to be **reduced in height by 5mm**.

SELF-SUPPORTING HEAD › Follow the standard Enigma instructions to calculate your studwork structural opening and add the following dimensions: **Width +94mm** and **Height +44mm**

IMPORTANT Refer to the specific **Self-supporting Head** installation instructions for further details.

OPENING CALCULATIONS

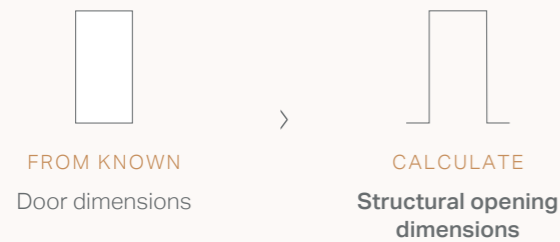

Single Door
Structural opening width = x2 Door leaf width +33mm
Structural opening height = Door leaf height +77mm

Double Doors
Structural opening width = x4 Door leaf width +32mm
Structural opening height = Door leaf height +77mm

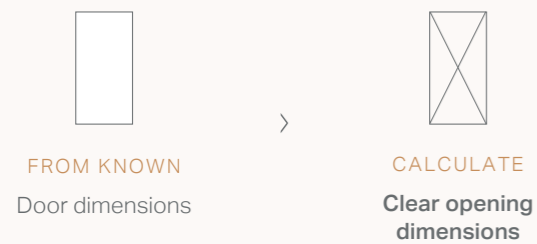

Single Door
Clear opening width = Door leaf width -75mm
Clear opening height = Door leaf height -17mm

Double Doors
Clear opening width = x2 Door leaf width -88mm
Clear opening height = Door leaf height -17mm

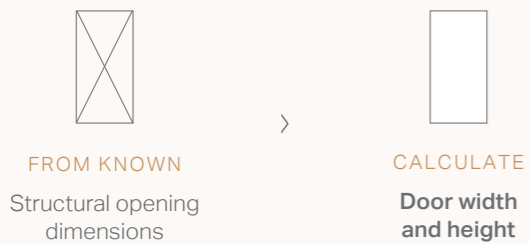

Single Doors
Door width = Structural opening width -33mm ÷ 2
Door height = Structural opening height -77mm

Double Doors
Door width = Structural opening width -32mm ÷ 4
Door height = Structural opening height -77mm

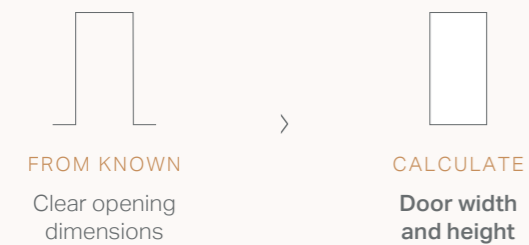

Single Door
Door width = Clear opening width +75mm
Door height = Clear opening height +17mm

Double Doors
Door width = Clear opening width +88mm ÷ 2
Door height = Clear opening height +17mm

Base Channel Calculations

Please refer to **Step 5** of the **Frame Installation** instructions shown on **page 12**.



1

STRENGTHEN HEAD

When constructing your stud partition, please ensure the head is strong enough to take the weight of the sliding door that will hang from it.

IMPORTANT

If using a **Self-supporting Head** please refer to those specific installation instructions.



2

CHECK SIZE WITH SCHEDULE

When forming the structural opening, please ensure you are working to the correct opening size provided on the door schedule.

IMPORTANT

If using a **Self Closer** please refer to those specific installation instructions.

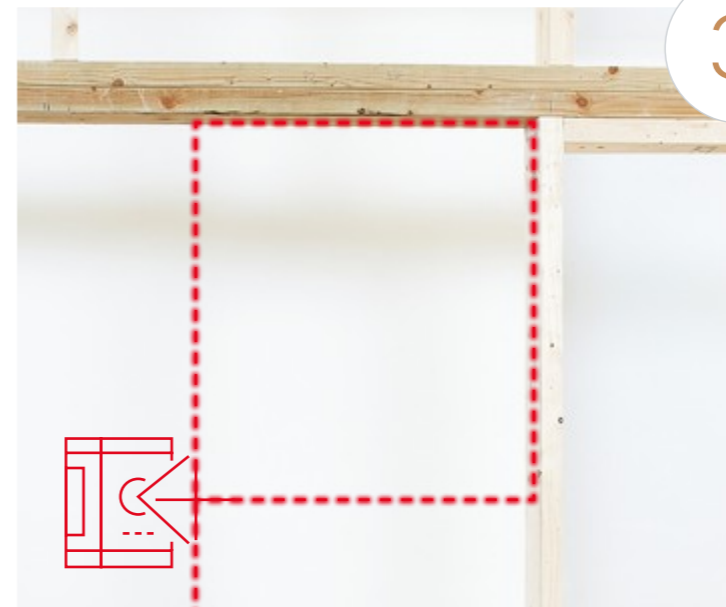

3

LEVEL-UP

Ensure the opening is square and plumb.

IMPORTANT

We strongly recommend the use of a laser level for setting out.

A) Frame installation

IMPORTANT Refer to the specific Self-supporting Head installation instructions for further details.



1 PREPARE HEAD CHANNEL & SLIDING TRACK

Single doors

1a Cut the **Head channel** to suit the structural opening width.

1b Remove the **Remote stop**, then cut the sliding top track to the structural opening width, **less 80mm**.

Double doors

Measure the structural opening width, divide in half and cut two head channels to that length. Cut the sliding track **40mm less** than the head channel length.



2 HEAD CHANNEL PREPARATION

Single doors

2a Mark **75mm** from the end of the head channel.

Double doors

Mark **30mm** from one end of both head channels.

2b Line the end of the top track with the mark and pilot drill the holes through the **Head channel**.

IMPORTANT

Ensure the groove in the centre of the track and the head channel line up as shown.



3 INSERT THE REMOTE STOP

Add after groove in the track 'as shown on photo. The white plastic clip needs to be located at the rear of the pocket, the opposite end of the track from that used to mark the **75mm** line on the **Head channel**.

IMPORTANT

1. If you are using the soft close mechanism, please refer to soft closer instructions before proceeding.
2. If using any of the following devices then please do not insert the remote stop:
 - › Soft Close & Open
 - › Touch Latch



4 FIT THE HEAD CHANNEL AND TOP TRACK

Single doors

4a Put the **Head channel** in place and fix using **Type-2** screws. The end with 75mm marked butts against the strike stud.

4b Line the top track with the pilot drilled holes and fix using **Type-3** screws. Only use the silver **Type-3** screw provided to secure the track into place - Use of a larger screw will prevent the **Remote stop** from sliding freely within its groove. It will be necessary to slide the **Remote stop** back to access all the fixing holes in the track.

Double doors

Butt the ends of the **Head channels** marked **30mm** from the end together in the centre of the structural opening width.

Base channel position calculations

FD30 Visible Trim (T FR)

SINGLE X = Door Width (plus) +5mm

DOUBLE X = Door Width (minus) -12mm from centre line

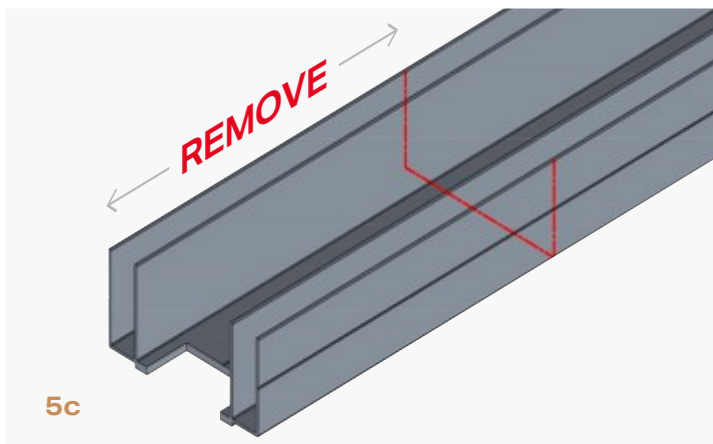
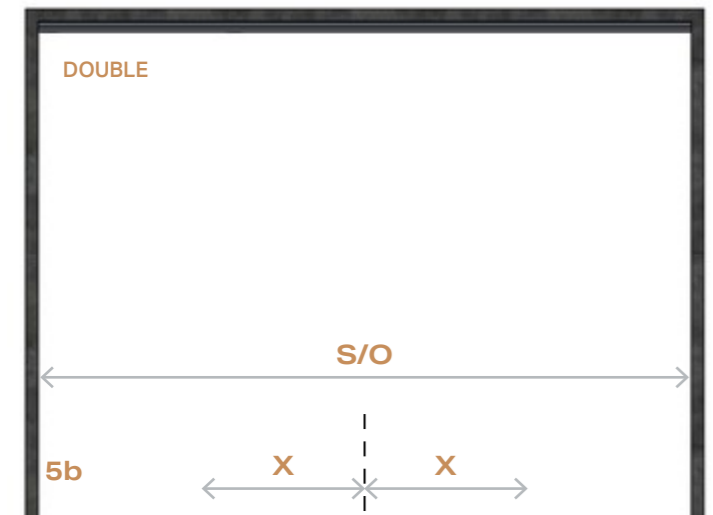
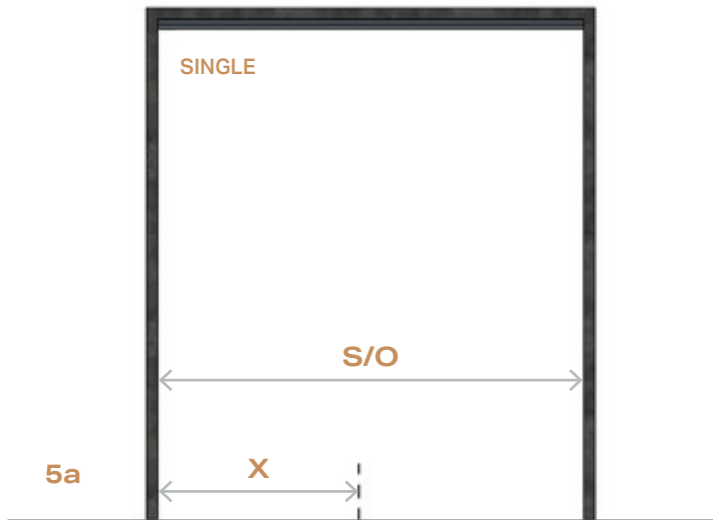

5

CALCULATE LENGTH OF BASE CHANNEL

IMPORTANT

If provided with a cut-to-size system, skip to Step 6

Single Doors

To accurately determine the length of the **Base channel**, first calculate the required clear opening (X) using the Base channel position calculations on the left.

Measure back from the **Strike stud** and mark the measurement on floor. *Image 5a*

Cutting Base channel to size

Measure the **Structural Opening** and minus the X calculation(s).

Cut the **Base channel** to this dimension, cutting off the end with the notch. *Image 5c*

Proceed to **Step 6**.

Double Doors

Mark the centre of the **Structural Opening (S/O)** width onto the floor. Calculate the required clear opening (X) using the Base channel position calculations on the left.

Measure back from **S/O centre mark** in both directions and mark on the floor. *Image 5b*

Cutting Base channel to size

Measure the **Structural Opening** and minus the X calculation(s).

Cut the **Base channel** to this dimension, cutting off the end with the notch. *Image 5c*

Proceed to **Step 6**.

6

LINING UP & FIXING BASE CHANNEL

Place the **Base channel** on the floor between the line marked in **Step 5** and the rear stud.

At this stage it is vital that care is taken to ensure that the centre line of the **Base channel** is in line and plumb with the **Head channel**. Any deviation in this alignment will result in misaligned doors and trims.

Secure to the ground with **Type-2** fixings.

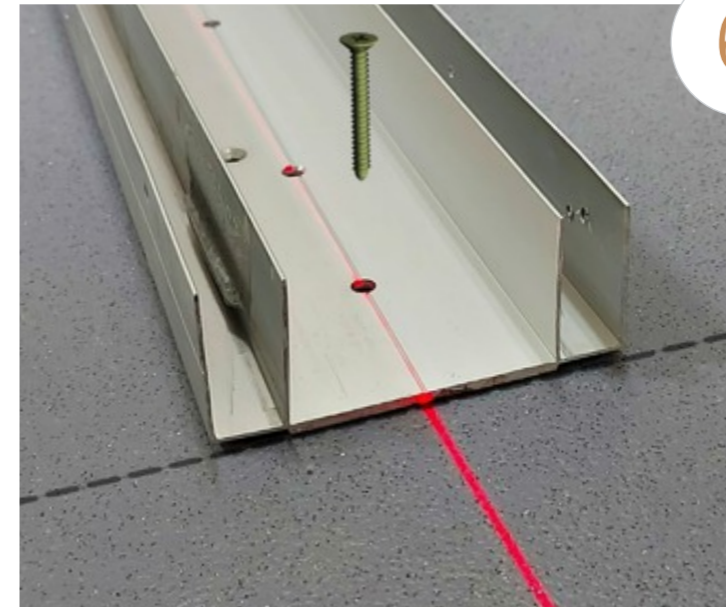

7

CUT LEADING EDGE & INTERMEDIATE JAMB

Cut the **Leading edge jamb** and **Intermediate jamb** 15mm less than the structural opening height.



8

CUT & FIT INTERMEDIATE TIMBER INSERT

Cut the intermediate **Timber insert** 100mm shorter than the aluminium jamb and slide the insert into the **Intermediate jamb** so it sits 50mm from each end.

IMPORTANT

When using door leaves wider than 926mm the kit will be supplied with extra intermediate jambs to be fitted equally space within the pocket width.



9

FIT POCKET SIDES & FIX THE JAMB



9a

9a Slide the **Intermediate jamb** into the **Head channel** and **Base channel** with the **Timber inserts** facing out so it sits centrally in the pocket. Fix using **Type-1** screws.

9b Slide the **Leading edge jamb** into **Base channel** with notched end at the top, so the flange sits hard against the end of the **Base channel**.

Plumb the jamb and fix into place using one **Type-1** screw top and bottom as shown in the image. Must be positioned furthest from the opening.



9b

10

FIT DOOR GUIDE PIN

Fit the door guide pin at the finished floor level with **Type-4** fixings. The pin offset needs to be facing the strike stud and aligned centrally with the centre line on the base channel.

If your installation requires the door guide pin to be raised up - use the 1mm stackable packers

IMPORTANT

1. The pin needs to be fitted at FFL (finished floor level). If the finished floor is not yet installed, fitment of the floor pin can be delayed until the flooring is completed.
2. If you are installing an acoustic Enigma to achieve 25dB and above then the pin will need to be offset to suit the door. Fit the pin once you have the door to hand to ensure you can set the position correctly.

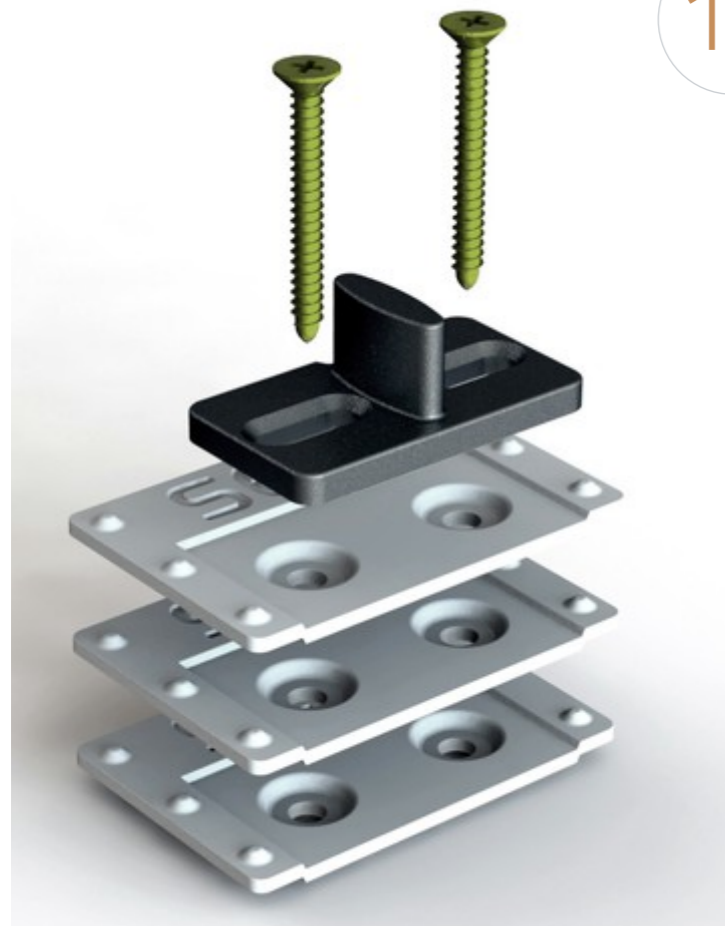

11

FIT THE PACKER

In order to support the pocket sides before plasterboarding, insert the pocket packer into the pocket as shown.



12

PLASTERBOARD THE WALL

Plasterboard over the pocket along with the rest of the wall using the **Type-5** self drilling screws provided. It is vital to ensure the leading edge jambs remain completely vertical and plumb once boarded. It is essential to clear out all swarf or debris that may be in the top track and bottom channel at this stage.

IMPORTANT

The cardboard packer must be used to stop the side walls bowing when fixing plasterboard to the pocket.



13

FIT BRUSH STRIP

Cut the **Brush Strip** to length and fit to the leading edge aluminium profile.

IMPORTANT

If using simultaneous opening ensure that the door leafs and head trims have been fitted. Refer to the simultaneous opening instructions for more.



B) Door leaf installation

With the FD30 visible system, the door leaf needs to be hung before the trim is fitted.

1

FIT HEAD BRACKETS

Fit the head brackets **150mm** from the edge of the door leaf to centre of the bracket, ensuring both brackets are the same way up. Use the screws provided.

IMPORTANT

1. If you are using the **simultaneous opening** mechanism then it needs to be installed now. If using a simultaneous opening the door leaf height needs to be reduced by an extra 5mm.
2. If you are using a **soft close** mechanism please refer to the soft close instructions to install the door leaf.
3. If using a **self closer** then please refer to the self closer installation instructions.
4. If using a **touch latch**, fit the spring plunger into the rear of the door as per the touch-latch instructions.

2

FIT THE GUIDE CHANNEL

Apply a thin bead of adhesive into the groove in the bottom of the door and then tap the plastic channel into position.

3

ASSEMBLE GEAR

3a Screw the bolts into the trolley several turns and then insert the trolleys into the track.

3b Adjust the bolts to achieve a gap approximately **20mm** between the underside of the track and the top of the bolt.

3a

3b

4

HANG THE DOOR

4a The bracket fits onto the bolt as shown.

4b Feed the rest of the door at least halfway into the pocket and hang the front bracket onto the trolley bolt.

4c With spanners provided, wind the bolts up or down to plumb the leading edge of the door and to achieve the required gap under the door (door undercut).

Tighten the locking nuts to secure the door to the brackets. They may need to be slacked-off later, to true the door to the trims once they are fitted.

4a

4b

4c



5

FIT THE FRONT THE DOOR STOP

Slide the white nylon door stop into the track and fix into place by tightening the grub screw.

This can be finally adjusted once the trims are installed.

IMPORTANT

If using a soft closer follow the specific soft closer instructions.



6

FIT TRACK END BLOCK

The track end block fits at the end of the track for a single door and in the middle of the two tracks for a double door.

First drill a pilot hole and fix the block into place using the **Type-9** screw.



C) Visible trim installation

Familiarise yourself with components included. All fixings will come pre-packaged to suit your specific project requirements.

SUPPLIED TOOLS



Hex Key

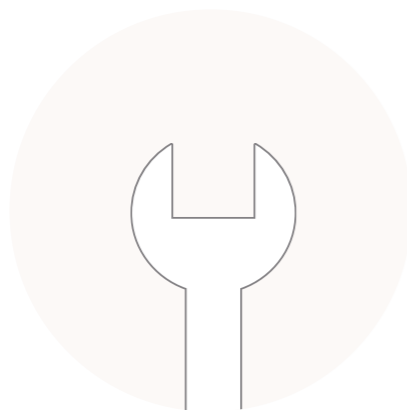

Spanner

TRIM FIXINGS



Type-5
25mm self-drilling screws



Type-6
60mm gold screws



Type-9
50mm gold screws

TRIM COMPONENTS



FD30 Strike Trim Pt1
Single door x1 / Double door n/a

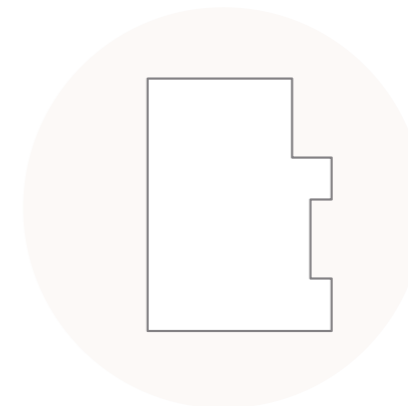

FD30 Strike Trim Pt2
Single door x2 / Double door n/a

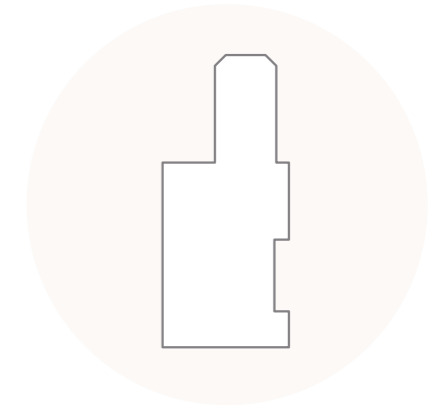

FD30 Head Trim
Single door x1 / Double door x2



FD30 Leading Edge Trim
Single door x2 / Double door x4

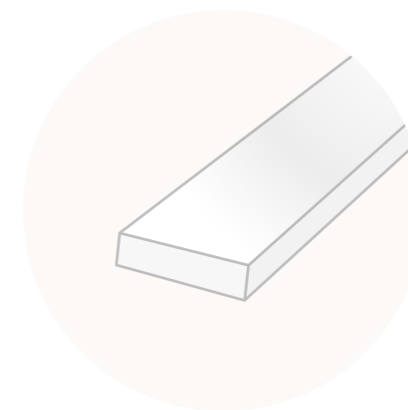

Intumescent Seals
15x4mm

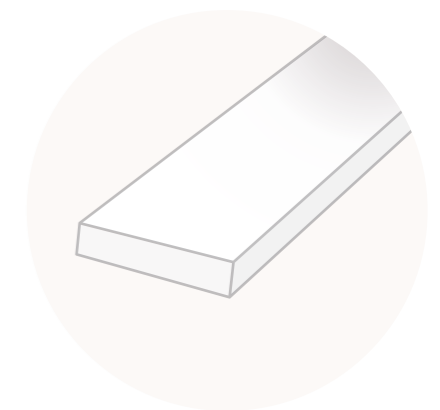

Intumescent Seals
20x4mm



Strike Jamb Seals



1

INSTALL LEADING EDGE TRIM

Cut the **Leading Edge Trims** to the height of the opening and slot them over the flange on the leading-edge aluminium jamb, with the grooves for the brush/intumescent seal facing in towards the door.

They must be secured into position with the **Type-5** screws at **300mm** intervals. Please note that the timber will need to be pilot-holed first.



2

LINE THE DOOR UP

If required, the door can now be trued into alignment with the leading-edge trims by adjusting the hanger bolts up or down as necessary.

When you're happy that everything is aligned and the gaps between the door and trims are equal, lock the bolts firmly into position by winding down the locknuts.

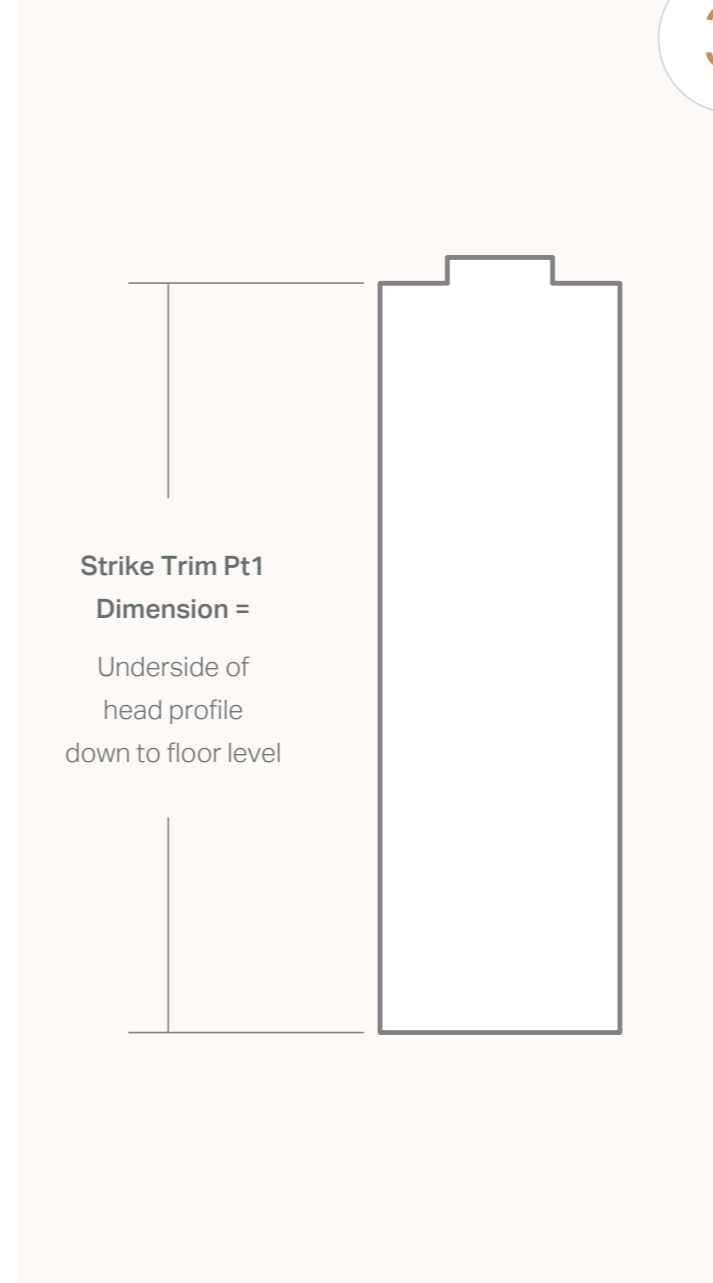

3

CUT TO LENGTH STRIKE TRIMS

Cut **Strike Trim Pt1** as per the drawing measuring from the notch to the end that is not notched.

Cut **Strike Trims Pt2** to the same length.

IMPORTANT

When installing double doors the strike jamb will not be used.



4

INSTALL STRIKE TRIM

Fit the notched end of **Strike Trim Pt1** centrally in the head channel and plumb down using a level. Fix into place using the **Type-9** screws.

Fit the **Strike Trim Pt2** to either side of **Strike Trim Pt1** and fix into place using the **Type-6** screws.



5

SET CLOSER STOP

Adjust plastic clip, so the door leaf closes and is held in place, against the strike jamb.



6

INSTALL HEAD TRIMS

Cut the head trim to the distance between the two timber side jambs. Slot into place in the head using **Type-5** screws.

Screws should be positioned every 300mm.

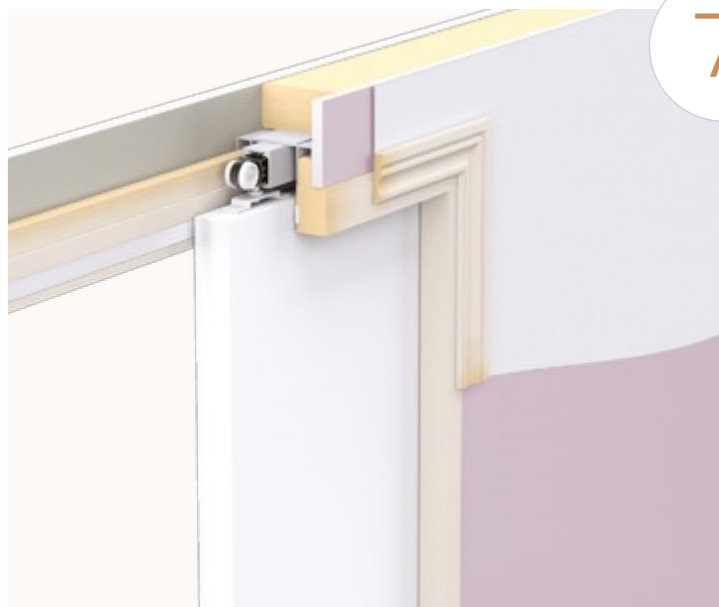

7

TAPE & JOINT / PAINT

Now the wall can be tape and jointed and wall and trims painted.

IMPORTANT

We recommend tape and jointing not plastering.

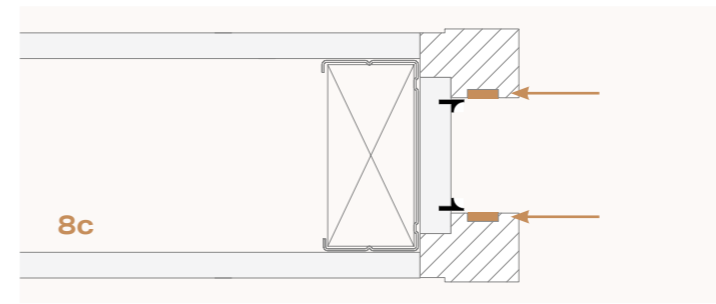
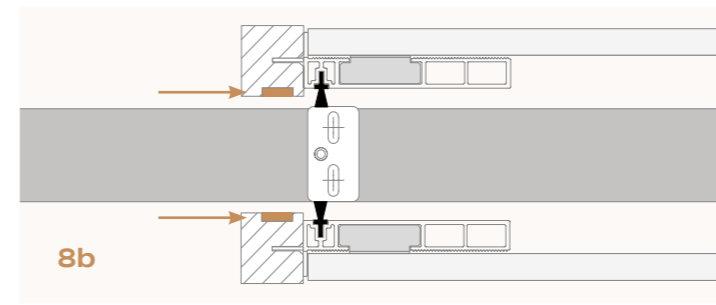
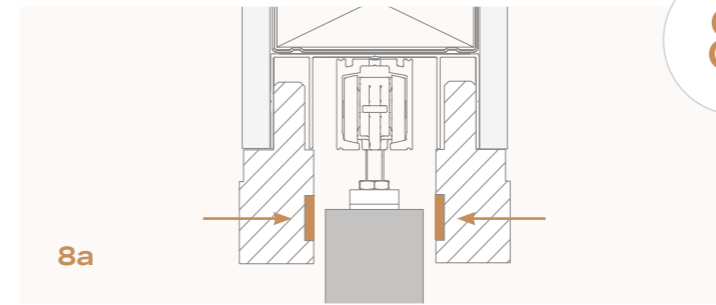

8

FIT INTUMESCENT SEALS

In order to achieve a FD30 fire rating, intumescent seals must be fitted as shown.

8a Head

8b Leading edge

8c Closing edge

If you have double doors the meeting stile of one door leaf needs the seals fitted as shown below. These will be specifically labelled in the pack you receive.

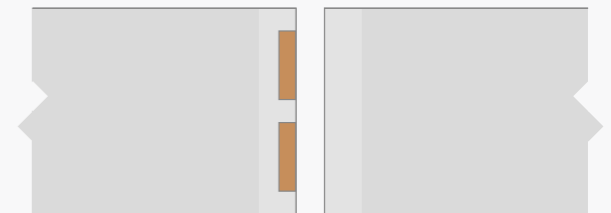

9

FIT BATWING STRIKE SEALS

Fit the rubber seals to the corners of the strike trim as shown.



10

ADJUST REMOTE STOP

Adjust the remote-stop so it holds the door flush with the leading-edge trims when the rear trolley is engaged on the stop.

When correctly aligned, fix the stop into place with the self-drilling screw provided making sure that all swarf is wiped/hovered from the track. Any debris left in the track will cause the door to 'rumble' as it opens and closes.



Congratulations!

You've now completed the installation of your Enigma doorset.

Innovation | Configuration | Strength

The Complete Pocket Door System



Visit our website for the very latest design styles.

www.enigmapocketdoors.com



ENIGMA
SLIDING POCKET DOORS

Technical support helpline 020 3880 0339

Email sales@enigmapocketdoors.com

K2 Kents Hill Business Park Timbold Drive Milton Keynes MK7 6TT

INNOVATION BY SELO.